

tineco

FLOOR ONE S5 SERIES Smart Cordless Vacuum & Washer

Instruction Manual

Manual De Uso

Mode D'emploi



*Actual product may differ from illustration.

TINECO IS HERE TO HELP.
We'll get back to you within 1 business day.



 www.tineco.com

 **1-855-292-8864**
Mon. - Fri. 9am - 6pm (CST)

CONTENTS

| | |
|------------------------------------|----|
| Important Safety Instructions..... | 2 |
| Overview..... | 6 |
| Accessories..... | 8 |
| Assembly..... | 9 |
| Operation..... | 10 |
| Maintenance..... | 16 |
| Specifications..... | 20 |
| Troubleshooting..... | 21 |
| Warranty..... | 22 |



TINECO IS HERE TO HELP.
We'll get back to you within 1 business day.

 www.tineco.com

 **1-855-292-8864**
Mon. - Fri. 9am - 6pm (CST)

Important Safety Instructions

SAVE THESE INSTRUCTIONS

Household use only.

When using an electrical appliance, basic precautions should always be followed, including the following:

READ ALL INSTRUCTIONS BEFORE USING (THIS APPLIANCE). Failure to follow the warnings and instructions may result in electric shock, fire and/or serious injury.

WARNING – To reduce the risk of fire, electric shock, or injury:

1. This appliance can be used by children aged from 8 years and above and persons with reduced physical, sensory or mental capabilities or lack of experience and knowledge if they have been given supervision or instruction concerning use of the appliance in a safe way and understand the hazards involved. Children should not play with the appliance. Cleaning and user maintenance shall not be performed by children without supervision.
2. The appliance is not to be used by persons (including children) with reduced physical, sensory or mental capabilities, or lack of experience and knowledge, unless they have been given supervision or instruction.
3. Use only indoors, on non-carpeted floor surfaces such as vinyl, tile, sealed wood, etc. Be careful not to run over loose objects or edges of area rugs. Stalling the brush may result in premature belt failure.
4. Do not allow to be used as a toy. Close attention is necessary when used by or near children, pets or plants.
5. Use only as described in this manual. Use only manufacturer's recommended attachments.
6. Do not use with a damaged cord or plug. If appliance has been dropped, damaged, left outdoors, dropped into water, or is not working as it should, return it to a service center.
7. Do not handle charger, including charger plug, and charger terminals with wet hands.
8. Do not put any object into openings. Do not use with any opening blocked; keep free of dust, lint, hair, and anything that may reduce air flow.
9. Keep hair, loose clothing, fingers, and all parts of your body away from openings and moving parts.
10. Use extra care when cleaning on stairs.
11. Do not use to pick up flammable or combustible liquids, such as gasoline, or use in areas where they may be present.
12. Do not pick up anything that is burning or smoking, such as cigarettes, matches, or hot ashes.
13. Do not use without filter.
14. Prevent unintentional activation. Ensure the switch is in the off-position before picking up or carrying the appliance. Carrying the appliance with your finger on the switch or energizing appliance that have the switch on invites accidents.
15. Always switch off the appliance before making any adjustments, changing accessories, or storing the appliance. Such preventive safety measures reduce the risk of starting the appliance accidentally.

16. Recharge only with the charger specified by Tineco. A charger that is suitable for one type of battery pack may create a risk of fire when used with another battery pack.
17. Use appliances only with specifically designated Tineco battery packs. Use of any other battery packs may create a risk of injury and fire.
18. Under abusive conditions, liquid may be ejected from the battery; avoid contact. If contact accidentally occurs, flush with water. If liquid comes into eye contact, seek medical help. Liquid ejected from the battery may cause irritation or burns.
19. Do not use a battery pack or appliance that is damaged or modified. Damaged or modified batteries may exhibit unpredictable behavior resulting in fire, explosion or risk of injury.
20. Do not expose a battery pack or appliance to fire or excessive temperature. Exposure to fire or temperature above 266°F (130°C) may cause an explosion.
21. Follow all charging instructions and do not charge the battery pack or appliance outside of the temperature range specified in the instructions. Charging improperly or at temperatures outside of the specified range may damage the battery and increase the risk of fire.
22. Have servicing performed by a qualified repair person using only identical replacement parts. This will ensure that the safety of the product is maintained.
23. This appliance contains battery cells that are non-replaceable. Do not modify or attempt to repair the appliance or the battery pack except as indicated in the instructions for use and care.
24. Always turn off this appliance before connecting or disconnecting the motorized nozzle.
25. Do not charge or store the appliance outdoors or inside the car. Only charge, store or use the battery in a dry indoor area where the temperature is higher than 39.2°F (4°C) but lower than 104°F (40°C). The charger is for indoor use only.
26. Do not use to pick up ultrafine particles, such as lime, cement, sawdust, gypsum powder, or ashes.
27. Do not use to pick up sharp objects, such as metallic nails, pieces of glass, metal paper clips, or pins.
28. Do not use to pick up hazardous material and chemicals, such as solvent, drain cleaner, strong acids, or strong alkali.
29. Stop using immediately if the appliance is overheating, making unusual noises, producing unusual odors, performing low suction, or leaks electricity.
30. Turn cleaner OFF and disconnect from electrical outlet for long-term storage.
31. Always clean the Dirty Water Tank after each use to avoid potential blockage, which may lead to low suction power, motor overheating, or reduce the service life of the appliance.
32. Store appropriately indoors in a dry place after use.
33. Do not place or submerge appliance in standing water or try to clean flooded areas.
34. All data and technical instructions of this manual are based on results from lab tests of Tineco or designated third parties. The company reserves all rights for final explanations.
35. The plug must be removed from the socket-outlet before cleaning or maintaining the appliance.
36. A hazard may occur if the appliance runs over the supply cord.
37. Do not use the appliance when the water depth is more than 5mm above the surface.

Range of Usage

1. The cordless hard floor cleaner is to be used on indoor hard floors, such as vinyl, tile, sealed wood, etc. Use on a rough surface may not get the best performance.
2. Keep your appliance away from heat sources, such as fireplace or heater, to avoid casing deformation.
3. Do not use to pick up flammable or combustible liquids, ultrafine particles, sharp objects, hazardous material, chemicals or anything that is burning or smoking, as described above.

About Cleaning Solution

1. A large amount of cleaning solution entering into the motor may cause damage to the appliance.
2. Add solution as instructed in the Operation section. We recommend using the provided cleaning solution. Do not use the product with acidic, alkaline solution, or any substances harmful to the environment.
3. Keep out of reach of children. If any solution gets into the eyes, immediately flush them with clean water. If any solution is swallowed by accident, seek medical care immediately.
4. Dirty water and solution disposal should comply with local environmental regulations.

About the Appliance

1. Do not modify or attempt to repair the appliance except as indicated in the instructions for operating and cleaning.
2. Charge the appliance with the Tineco adaptor. Input Voltage: AC 100-240V. Both high and low voltages can damage the adaptor, appliance, or even cause danger to the user.
3. Use extra care when cleaning on stairs.
4. Ensure that the Power Switch is in the OFF-position before picking up or carrying the appliance. Do not lay flat or lean the appliance so as to prevent dirty water from entering into the motor.
5. To avoid being tripped accidentally, please put away the appliance on the charging base.
6. Always install the Dirty Water Tank and Clean Water Tank properly before use.
7. Do not allow the appliance or charger to get wet to avoid risk of fire or injury caused by a short circuit.

FCC Supplier's Declaration of Conformity

TINECO / FLOOR ONE S5 SERIES

This appliance complies with part 15 of the FCC Rules. Operation is subject to the following two conditions:

(1) This appliance may not cause harmful interference, and (2) this appliance must accept any interference received, including interference that may cause undesired operation.

TINECO INTELLIGENT, INC.

1700 WESTLAKE AVENUE N., SUITE 200, SEATTLE, WA, 98109, USA

WWW.TINECO.COM

1-855-292-8864

Changes or modifications not expressly approved by the party responsible for compliance could void the user's authority to operate the equipment.

Note: This equipment has been tested and found to comply with the limits for a Class B digital appliance, pursuant to Part 15 of the FCC Rules. These limits are designed to provide reasonable protection against harmful interference in a residential installation.

This equipment generates uses and can radiate radio frequency energy and, if not installed and used in accordance with the instructions, may cause harmful interference to radio communications. However, there is no guarantee that interference will not occur in a particular installation. If this equipment does cause harmful interference to radio or television reception, which can be determined by turning the equipment off and on, the user is encouraged to try to correct the interference by one or more of the following measures:

- (1) Reorient or relocate the receiving antenna.
- (2) Increase the separation between the equipment and receiver.
- (3) Connect the equipment into an outlet on a circuit different from that to which the receiver is connected.
- (4) Consult the dealer or an experienced radio/TV technician for help.

FCC Radiation Exposure Statement

This equipment complies with FCC radiation exposure limits set forth for an uncontrolled environment. This equipment should be installed and operated with a minimum distance of 20cm between the radiator and any part of your body.

Note

The manufacturer is not responsible for any radio or TV interference caused by unauthorized modifications to this equipment, such modifications could void the user's authority to operate this equipment.

IC Note

This appliance contains licence-exempt transmitter(s)/receiver(s) that comply with Innovation, Science and Economic Development Canada's licence-exempt RSS(s). Operation is subject to the following two conditions:

- (1) this appliance may not cause interference.
 - (2) This appliance must accept any interference, including interference that may cause undesired operation of the appliance.
- This Class B digital apparatus complies with Canadian ICES-003.
 - This equipment complies with ISED RSS-102 radiation exposure limits set forth for an uncontrolled environment. This equipment should be installed and operated with a minimum distance of 20cm between the radiator and any part of your body.

Overview

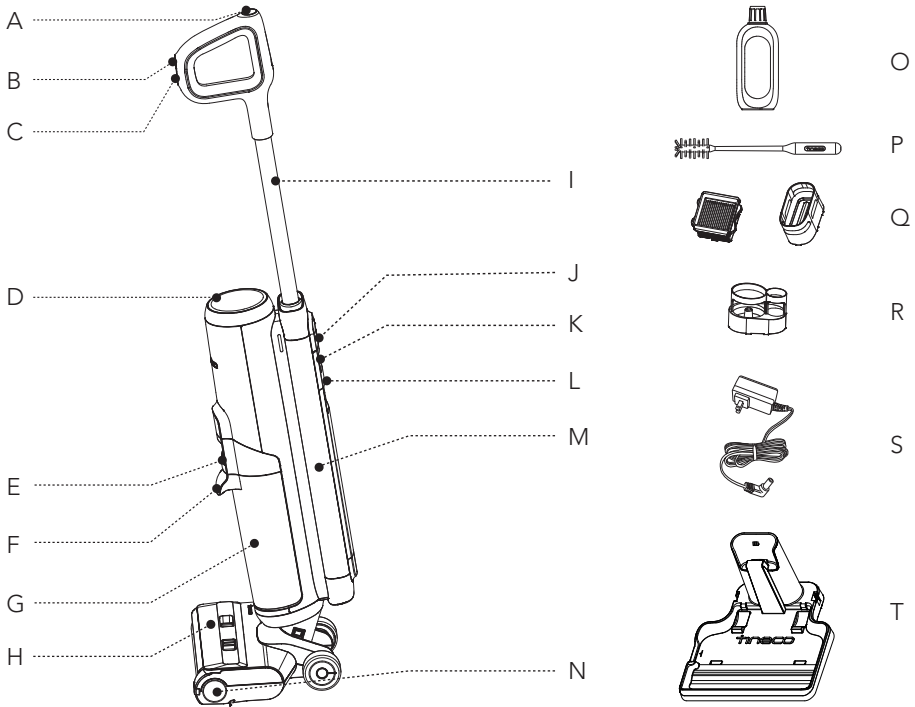

- A. Self-cleaning Button
- B. AUTO/MAX Mode
- C. Power On/Off
- D. Digital Display
- E. Dirty Water Tank Release
- F. Dirty Water Tank Handle
- G. Dirty Water Tank (DWT)
- H. Brush Roller Cover
- I. Tube
- J. WiFi/Mute Button
- K. Clean Water Tank Release
- L. Clean Water Tank Handle
- M. Clean Water Tank (CWT)
- N. Brush Roller
- O. Deodorizing & Cleaning Solution
- P. Cleaning Tool
- Q. Dry Filter & Holder
- R. Accessory Holder
- S. Adaptor
- T. Charging Base

EN

Digital Display

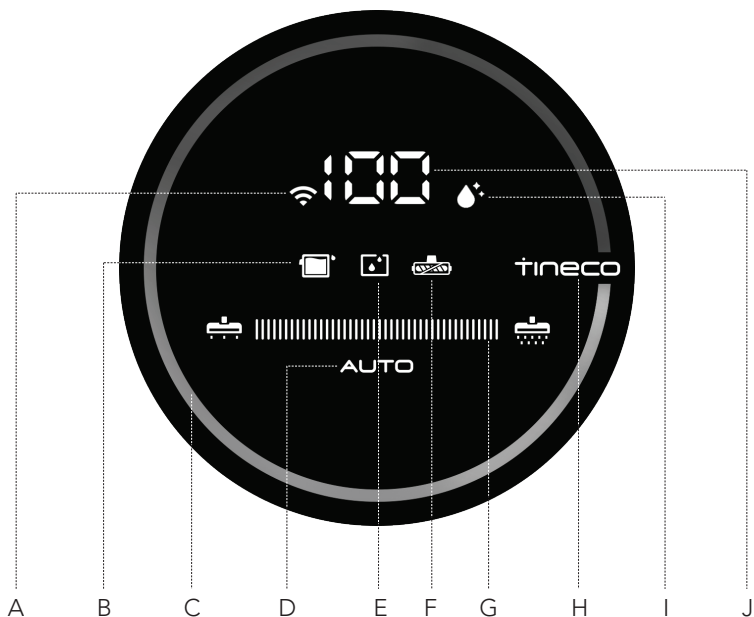

- A. WiFi Indicator
- B. DWT Full or Blocked
- C. Dirt Monitoring Loop
(Blue to red according to the dirt amount)
- D. AUTO Mode
- E. CWT Empty
- F. Brush Roller Tangled Indicator
- G. Power Indicator
- H. Tineco Logo
- I. Self-cleaning Icon
- J. Battery Level Indicator

Accessories

Note:

Accessories may vary between markets. If you require more accessories, please go to www.tineco.com or store.tineco.com.

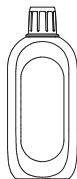

Deodorizing & Cleaning Solution

Removes dirt, grime, grease and tough stains from most types of hard surfaces, like tile, marble, sealed hardwood floors, and more. Always use Tineco solution in your appliance.

Add one bottle cap of solution to each full tank of clean water.



Brush Roller

Soft roller head with bristles can be used to vacuum and wash at the same time. It can be easily cleaned with the self-cleaning function.

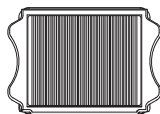

Dry Filter

Dry filter and filter net can block large particles and debris, ensure the appliance's durability.

* Please install the dry filter before use, or it may lead to weak suction.



Cleaning Tool

A full brush to clean the DWT, brush chamber and opening.

The tool also has a bristled end to remove dirt and mud on the roller and DWT.

Assembly

How to Assemble/Disassemble

Note:

For water tank and brush assembly, please refer to "Operation" and "Maintenance".

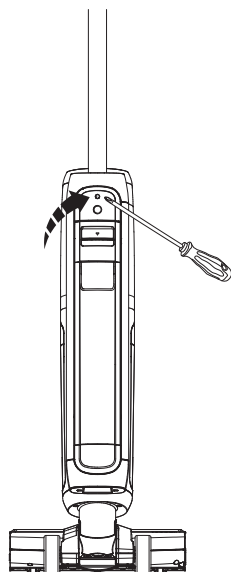
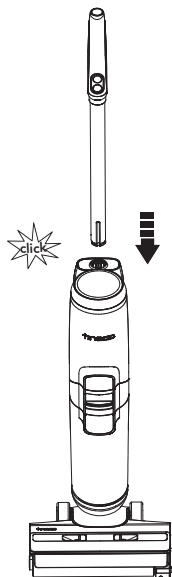

To assemble the handle, insert it into the appliance until you hear a click.

In the event that the product must be returned, please disassemble the handle. Press the spring to release the handle with a tool (like a screwdriver) and lift the released handle from the appliance.



Operation

Preparing for Use

Before first use, please charge the appliance for 4-5 hours (refer to "Charging Instructions" for details).

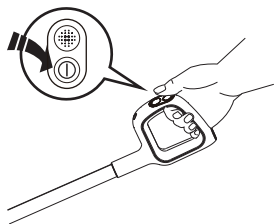
* Based on results from Tineco lab tests. Lab temperature 39.2°F (4°C) ~ 104°F (40°C).



Press the  button and the appliance will start in AUTO mode by default. Press it again to turn off the appliance. Switch between AUTO and MAX mode by pressing the  button.

Tips:

- Solution mode/ Water Only mode:
Appliance starts with Solution mode by default. Power on while the appliance is upright, long-press  for 3s to switch between the two modes.
- Switch to Water Only mode:
LED Loop: Red → Blue (use water only)
- Switch to Solution mode:
LED Loop: Blue → Red (use cleaning solution)

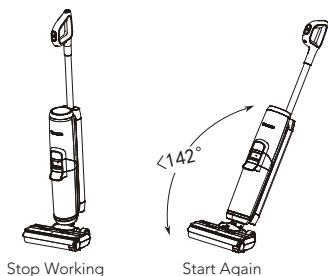

The appliance will stop working when put uprightly and start running again when you recline.

* Do not recline more than 142° to protect against water leakage.

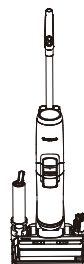

Place the appliance on the charging base vertically after use for recharge and storage.

Note:

- Selecting the appropriate mode depending on the CWT contents is vital for maximum dirt detection effectiveness.
- Do not vacuum foamed liquid.
- To vacuum water left on the surface, the appliance will switch off in 3 seconds after power off.

Filling Clean Water Tank



Press the Clean Water Tank release button to remove it from the appliance.

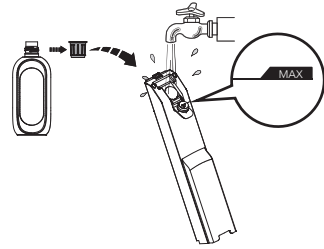

Open the tank cap, and fill with tap water to the Max line. When deep cleaning is necessary, add one bottle cap of solution to the CWT and tightly close the cap.

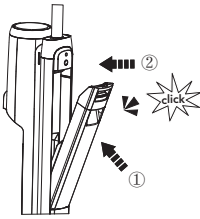

Place the tank back into the appliance. You should hear a "Click" if done correctly.

Charging Instructions

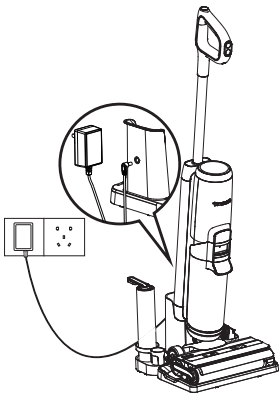

To charge the appliance, place the appliance on the charging base and plug the adaptor into a power outlet.

1. To charge the appliance, connect the external charging cord to the charging base and plug it into the wall outlet.
2. To avoid tripping hazards, please place the appliance on the charging base near a wall during charging.

Warning:

- Only charge the appliance with the adaptor supplied by Tineco.
- During long periods of not being used, the appliance must be charged once every 3 months for optimal performance. It may take 4-5 hours for a full charge.
- Store indoors in a dry place. Do not expose the appliance to sunlight or freezing temperatures. Recommended temperature range: 39.2°F (4°C) ~ 104°F (40°C).

Cleaning Mode Selection









AUTO Mode

- In AUTO mode, the iLoop™ sensor automatically detects how dirty the floor is and applies the appropriate amount of detergent and suction power.
- A red dirt monitoring loop indicates more dirt is detected, and a blue loop indicates less dirt is detected. This mode automatically provides the best cleaning solution.

EN



AUTO

| | | | |
|---|---|---|-------------------------------|
|  |  |  | Clean: on Min Power |
|  |  |  | Vary depending on dirt amount |
|  |  |  | Heavy dirt: on Max Power |

MAX Mode



- In AUTO mode, press the AUTO/MAX button to enter MAX mode. The AUTO indicator on the display will turn off.
- In MAX mode, the appliance will apply max suction power and will spray water/solution for deeper cleaning.

Note:

Keep sharp objects away from the digital display screen to avoid scratches and scrapes.

Runtime

- When in AUTO mode, the runtime is approximately 35 minutes. When MAX power is used, the runtime is approximately 28 minutes.
- Estimated runtime data was obtained by a Tineco Laboratory.

Charging Time

- A full charge takes approximately 4-5 hours.
- Estimated data was obtained by a Tineco Laboratory using ambient temperatures between 39.2°F (4°C) to 104°F (40°C).

Indicator

When in Use



Battery level \geq 10%: battery indicator will be illuminated.



Battery level $<$ 10%: battery indicator will be blinking.



Off: no power detected or possible battery malfunction.



Solid red light: dirt sensor malfunction or blocked.



Indicator blinking: CWT is empty.



Indicator blinking: DWT is full or channel has a blockage.



Indicator blinking: brush roller is not installed or has a blockage.



Illuminated: WiFi has successfully connected.



Blinking: WiFi is connecting.



Off: WiFi is not connected, please connect to the network.



Indicator blinking: appliance is in need of self-cleaning.

EN

During Charging



Tineco indicator: breathing.

Fully Charged



In 5 minutes: Tineco indicator illuminated.
After 5 minutes: all indicator lights turn off.

App

All the functions can be performed using the Tineco app. Download the Tineco app from the App Store, Google Play and Tineco Official Site.



Note:

The default setting for voice prompt is English, you can set other languages via App.

Voice Prompt (Contents may vary, please in kind prevail.)

| Status | Reminder |
|--|---|
| Voice prompts on | Voice prompts on |
| Voice prompts disabled | Voice prompts disabled |
| Auto mode by default | Auto mode |
| Switch to Max mode | Max mode |
| Cleaning with water only | Cleaning with water only |
| Cleaning with cleaning solution by default | Cleaning with cleaning solution |
| Battery level: 10~20% | Low battery |
| Battery level: 0~10% | Low battery, please charge |
| Clean Water Tank is empty | Clean Water Tank empty, please refill water and cleaning solution |
| Need self cleaning | Please begin self-cleaning cycle |
| Appliance not on the charging base | Please place appliance on charging base |
| Dirty Water Tank is full | Dirty Water Tank full, please empty |
| Dirty Water Tank not installed | Please install the Dirty Water Tank |
| Brush roller is tangled | Please clean the brush roller. |
| Brush roller not installed | Please install the brush roller correctly |
| Power is off | Power off |
| Start charging | Charging has commenced |
| Begin self-cleaning cycle. | Auto-detecting whether to run self-cleaning cycle, please begin self-cleaning cycle |
| Battery insufficient for self-cleaning | Low battery, start charging |
| Sufficient battery to start self cleaning | Start self cleaning |
| Cleaning brush roller | Cleaning brush roller |
| Cleaning debris channel | Cleaning debris channel |
| Auto detecting | Auto detecting |
| Deep cleaning | Deep cleaning |
| Self-cleaning stopped | Self-cleaning cycle stopped, please clean Dirty Water Tank |
| Self-cleaning complete | Self-cleaning cycle complete, please clean Dirty Water Tank |

Maintenance

Note:

- For optimal performance and to prevent odors, always **clean** and **dry** DWT, filters, brush roller, brush roller cover **completely** after each use.
- Please make sure each part is installed correctly or the appliance may not work properly.
- After maintenance, place the appliance on the charging base vertically. Do not expose the appliance to direct sunlight, and store it indoors in a dry place.

Main Body

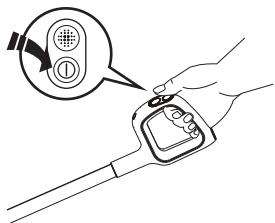

To reduce the risk of injury, switch off before performing maintenance.

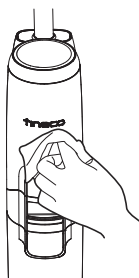

Use a cloth to clean the surface with a neutral detergent. The cloth should be dry to prevent water from entering the appliance.

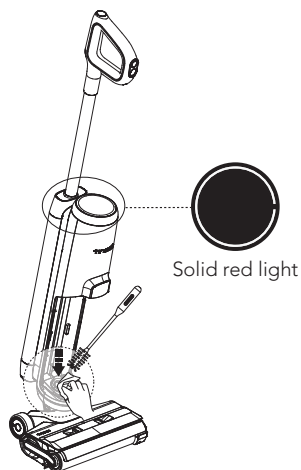

When LED loop illuminates red, remove Dirty Water Tank, clean the dirt sensor with a damp cloth or the cleaning tool.

Dirty Water Tank

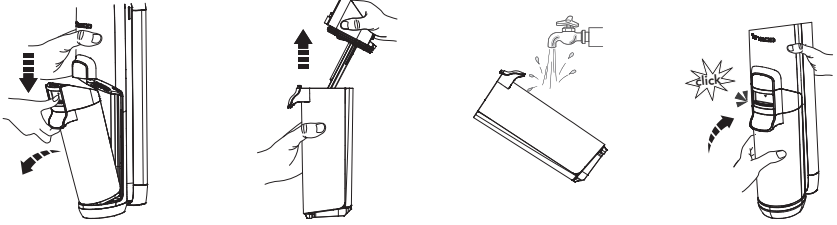

- When dirty water reaches the Max line, the appliance will stop working and show a reminder on the display and play a voice prompt.
- Pull up the tank lid to empty the DWT. Use the cleaning tool to remove remaining debris. Rinse the inside of the DWT and place back into the appliance.

NE

Dirty Water Tank Lid

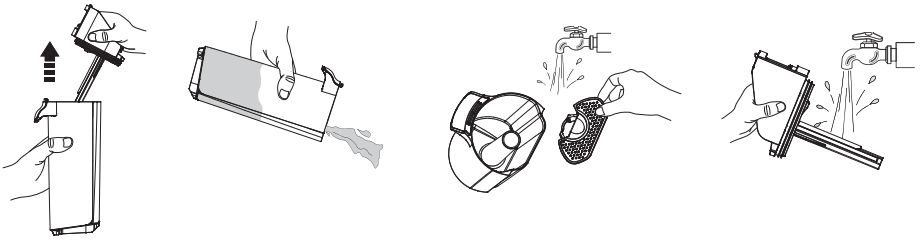

If the Dirty Water Tank lid and the filter inside have been blocked, remove the tank lid and the filter, rinse both parts with water.

Dry Filter



Grasp recessed area on each side of the dry filter and pull upward. Rinse under running water and must be completely dry before recombining with the lid of the DWT.

* A spare dry filter is provided with your appliance for convenient replacement.

Brush Roller Self-cleaning

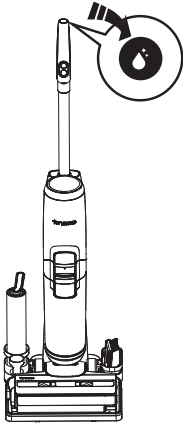

1. Place the appliance on the charging base after use, the sensor will auto-detect the level of dirt.
2. When you hear the voice prompt "please begin self-cleaning cycle," press the self-cleaning button and begin the process.
3. Once complete, you will hear the voice prompt "self-cleaning completed, please clean the Dirty Water Tank." At this point, the appliance will begin charging.

Note:

- Ensure the charging base is plugged in and the battery level is >10%.
- Before self-cleaning cycle, please clean the DWT and ensure the water level in the CWT exceeds 40%.

Brush Roller Cover

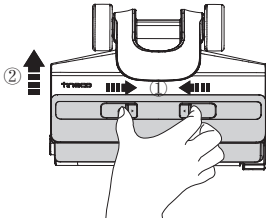

Squeeze latches on the cover and pull upward to remove.

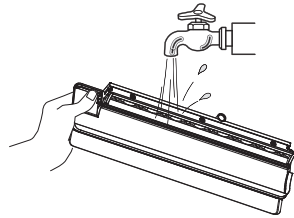

Rinse with water.

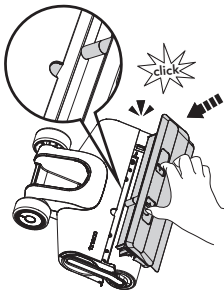

When replacing, always latch the brush cover into place to avoid leakage.

Brush Roller

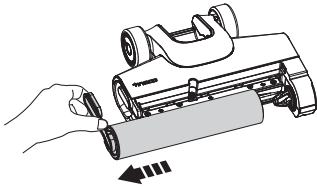

Remove the brush roller by grabbing the brush roller tab and pulling out.

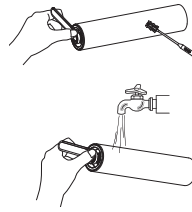

Using the cleaning tool, remove the hair and debris wrapped around the roller and rinse with water. Replace the brush roller back into the accessory holder, and allow it to dry completely before reinstalling.

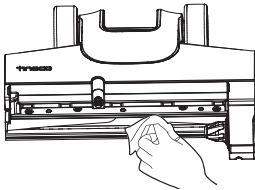
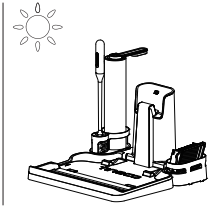

Remove hair and debris from the brush roller chamber and the opening with a tissue or a damp cloth.

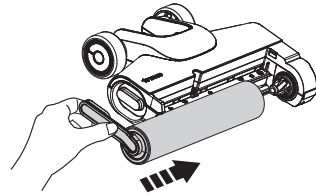

Replace the brush roller by inserting the brush roller end into the right side of the holder, then attach the roller tab to the magnetic buckle on the left side to lock into place.

Note:

A spare brush roller is provided with your appliance for convenient replacement.















Specifications

| | |
|-----------------|------------------------------|
| Product | FLOOR ONE S5 SERIES |
| AC Input | 100~240V |
| Voltage | 21.6V \approx 4000mAh Lion |
| Rated Power | 220W |
| Running Time | AUTO: ~35 mins MAX: ~28 mins |
| Charging Time | 4-5 hrs |
| Water Flow Rate | 30~100ml/min |
| CWT Capacity | ~0.8L |
| DWT Capacity | ~0.7L |
| Waterproof | IPX4 |

Disposal

- The battery contains materials that are harmful to the environment and must be removed from the appliance before it is discarded.
- When removing the battery, the appliance must be powered off.
- Batteries, chargers, accessories and packaging should be sorted for environmental friendly recycling. Do not put them into fire, water or soil. Do not dispose of batteries and chargers into household waste! 
- If battery leakage contacts skin or clothing, immediately flush with water to avoid irritation and seek medical help.

Troubleshooting

| Problem | Possible cause | Solution |
|--|--|--|
| The appliance does not turn on | Auto protection for overheating | Restart after cooling down |
| Weak suction | The dry filter is not installed, or the dry filter is dirty | Install the dry filter or clean and allow it to dry completely |
| Brush roller tangled indicator blinking  Voice prompt: 1. Please clean the brush roller 2. Please install the brush roller correctly  | 1. The brush roller is blocked 2. The brush roller is not installed | 1. Remove blockages 2. Install brush roller correctly |
| WiFi indicator is off  | WiFi is not connected | Follow the in-app guide to connect to WiFi |
| CWT empty indicator blinking  Voice prompt: Clean Water Tank empty, please refill water and cleaning solution  | CWT is empty | Refill CWT |
| DWT full indicator blinking  Voice prompt: Please clean Dirty Water Tank  | The dirty water in DWT has reached the MAX line | Empty the dirty water and then reinstall the DWT |
| All lights off in operation  | Battery overheat or malfunction | Cool the appliance down and restart |
| Battery level indicator blinking  Voice prompt: Low battery, please charge  | Low battery | Charge the appliance, or restart |
| LED loop illuminates red  Voice prompt: Please begin self-cleaning cycle  | Dirt sensor malfunction or blocked | Remove blockages, clean the debris channel, or restart |
| Self-cleaning icon blinking  | Brush roller is dirty | Start self-cleaning |
| Power indicator blinking  | Motor malfunction | Contact Customer Service |

Note:

If the above troubleshooting guide fails to provide a solution, please visit our website www.tineco.com for further support.



Warranty

2-YEAR LIMITED WARRANTY

- Only applies to purchases made from authorized retailers of Tineco.
- Is subject to the adherence of the requirements outlined in this instruction manual, and is subject to further conditions outlined below.

WHAT IS COVERED?

- Your Tineco appliance has a 2-year warranty against original defects in material and workmanship, when used for private household purposes in accordance with the Tineco Instruction Manual. Motorized accessories and battery bought separately come with a 1-year warranty.
- This warranty provides, at no extra cost to you, all labor and parts necessary to ensure your appliance is in proper operating condition during the warranty period.
- This warranty will only be valid if the appliance is used in the country in which it was sold.

WHAT IS NOT COVERED?

Tineco shall not be liable for costs, damages or repairs incurred as a result of:

- Appliances purchased from an unauthorized dealer.
- Careless operation or handling, misuse, abuse and/or lack of maintenance or use not in accordance with the Tineco Instruction Manual.
- Use of the appliance other than for normal domestic purposes, e.g. for commercial or rental purposes.
- Use of parts not in accordance with the Tineco Instruction Manual.
- Use of parts and accessories other than those produced or recommended by Tineco.
- External factors unrelated to product quality and use, such as weather, modifications, accidents, electrical outages, power surges or acts of God.
- Repairs or alterations carried out by unauthorized parties or agents.
- Failing to clear blockage and other hazardous material from the appliance.
- Normal wear and tear, including normal wearing parts, such as clear bin, belt, filter, HEPA, brush bar, and power cord (or where external damage or abuse is diagnosed), carpet or floor damage due to use not in accordance with manufacturer's instructions or failure to turn the brush bar off when necessary.
- Reduction in battery discharge time due to battery age or use.

WARRANTY LIMITATIONS

- Any implied warranties relating to your appliance including but not limited to warranty of merchantability or warranty of fitness for a particular purpose, are limited to the duration of this warranty.
- Warranty coverage applies to the original owner and to the original battery only and is not transferable.
- This limited warranty gives you specific legal rights. You may also have other rights which vary by region.
- Manufacturer's warranties may not apply in all cases, depending on factors such as use of the product, where the product was purchased, or who you purchased the product from. Please review the warranty carefully, and contact the manufacturer if you have any questions.

WARRANTY SERVICE

Register: We highly recommend that upon purchase, you register your appliance on the Tineco official website (www.tineco.com) and enjoy exclusive benefits. To register, please enter the last 11 digits of the serial number (remove the Clean Water Tank and find it on the back of the appliance).

Failure to register your product won't diminish your warranty rights.

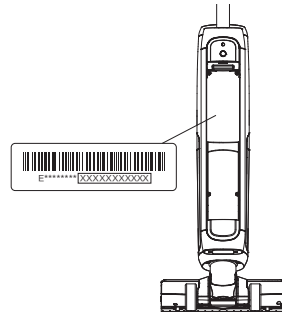

How to Claim: Please retain your proof of purchase. To make a claim under our Limited Warranty, you need to provide your serial number and the original purchase receipt with the purchase date and order number on it.

All work will be carried out by Tineco or its authorized agency.

Any replaced defective parts will become the property of Tineco.

Service under this warranty will not extend the period of this warranty.

Contact our Customer Service
Hotline: **1-855-292-8864**
or Visit Tineco website
www.tineco.com
for expert customer service.